

nickelodeon™
TEENAGE MUTANT NINJA
TURTLES



THEATER
MONSTER-MATINEE



Raph

Rooftop Blast-Out | Combat au Cinéma

Despegue de telhado | Ataque no Terraço | Sfida al Cinema

Dacheinsatz | Potyczka na dachu kina | Битва на крыше

4x
AM75332X

2x
MA1113AGV

1x
MA18623AGV

1x
AM76060AGV

1x
AM76776AQD

2x
M022501ZD

2x
MA07590AGV

2x
MA22501AGV

2x
MA09393MM

4x
MA09393F

4x
MA09393AGQ

2x
AM19326F

2x
AM74428AGV

8x
MA15484AGQ

2x
MA18549MM

1x
AM72090AGV

2x
MA17502AGV

1x
MA09013AGQ

4x
MA0948MM

1x
AS-DPF64-01

1x
AM16967AGV

1x
MA03773AGQ

12x
MA09023F

12x
MA17153AMR

2x
MA03772MM

1x
AM18615AGQ

4x
MA1087E

1x
AS-DPF64-04

2x
MA09493MM

1x
MA1480F

1x
MA1313F

1x
AS-DPF64-02
MONSTER MATINEE

1x
AS-DPF64-03
THEATER

3x
MA10233F

2x
AM76820APG

1x
AM18570AGV

1x
AM03514AGV

1x
AM18593AGV

1x
AM15064BOR

1x
AM76953AJK

2x
MA06618AGV

1x
AM15298W

1x
AS-DPF64-05

1x
AS-DPF64-06

1x
AM15297AMR

1x
AM15827RE

1x
MA08483AGQ

1x
MA17845MM

1x
MA74678MM

1x
MA18556MM

1x
AM76951MM

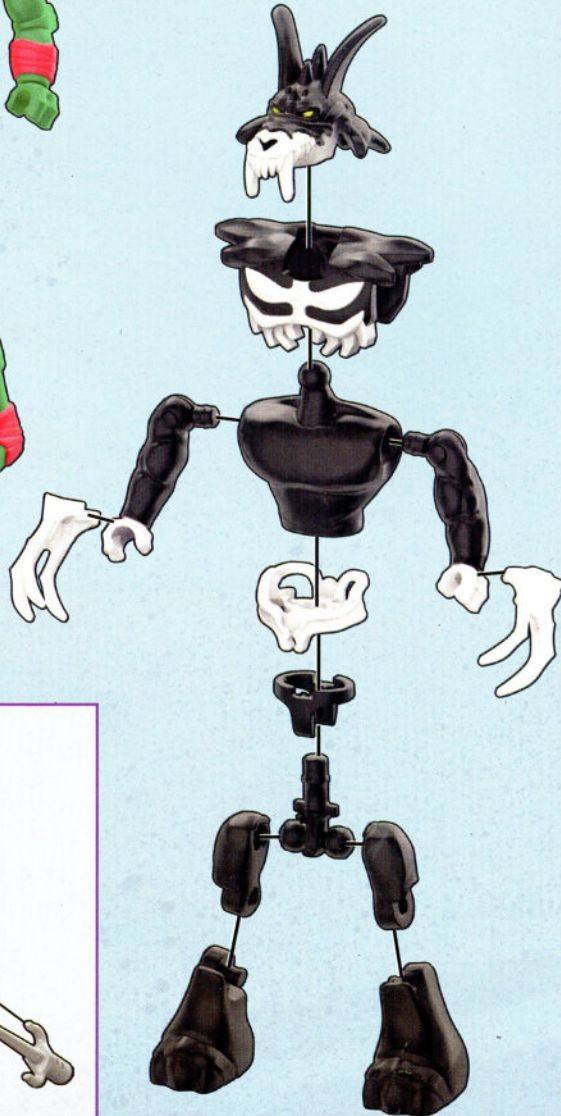
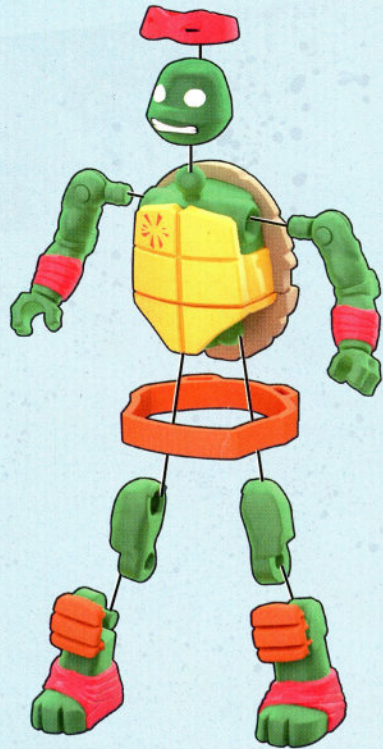

1x
FIG-DPF64-A



1x
FIG-DPF64-B

- ⚠ WARNING:
CHOKING HAZARD. - Small parts.
Not for children under 3 years.
- ⚠ ATTENTION:
DANGER D'ÉTOUFFEMENT. - Présence de petits éléments.
Ne convient pas aux enfants de moins de 3 ans.

⚠ تحذير:
خطر الاختناق - قطع صغيرة.
غير صالحة للأطفال أقل من 3 سنوات.

- ⚠ 警告:
噎住危險。包含有小部件
不适合3岁以下的小孩玩。

- ⚠ 警告:
のどにつまる危険 小さな部品が含まれています
3歳以下の子供には与えないで下さい。

ADVERTENCIA: Peligro de asfixia. Juguete no recomendado para menores de 3 años, porque contiene piezas pequeñas que podrían provocar asfixia en casode ser ingeridas o inhaladas por el/la niño/a.

ATENÇÃO: Não recomendável para crianças com menos de 36 meses. Contém peças pequenas capazes de criar risco de asfixia.

ATTENZIONE: Contiene pezzi di piccole dimensioni.

ACHTUNG: Kleine Teile.

OSTRZEŻENIE: Małe części

WAARSCHUWING: Kleine onderdelen

ΠΡΕΔΥΠΡΕΞΗΝΗ: Μελκμε деталη

ADVARSEL: Små dele.

VARNING: Smådelar

ADVARSEL: Små deler.

VAROITUS: Pieniä osia

ΠΡΟΣΟΧΗ: Περιλαμβάνονται μικρά κομμάτια.



Please read these instructions carefully before first use and keep them for future reference.

Il est recommandé de lire attentivement ce feuillet avant la première utilisation et de le conserver pour référence future.

Leer estas instrucciones cuidadosamente antes de la primera utilización y guardarlas para referencia futura.

Leia as instruções antes do primeiro uso e guarde-as para futura referência.

Leggere le istruzioni prima di cominciare ad usare il gioco e conservarle per referenze future.

Die Gebrauchsanleitung bitte durchlesen und aufbewahren.

Proszę uważnie przeczytać instrukcję obsługi przed pierwszym użyciem, a następnie zachować ją na przyszłość.

Wij raden u aan deze handleiding zorgvuldig te lezen en te bewaren voor eventuele raadgeving op een later tijdstip.

Внимательно прочитайте инструкцию перед первым использованием и сохраните ее для дальнейшего использования.

Vær venlig at læse disse instruktioner omhyggeligt inden ibrugtagten og opbevar dem til fremtidigt brug.

Läs noggrant igenom dessa instruktioner innan du använder produkten för första gången och spara dem för ev. framtida frågor.

Les disse instruksjonene nøye før første gangs bruk, og ta vare på dem for fremtidige oppslag.

Lue nämä ohjeet huolellisesti ennen ensimmäistä käyttöä ja säilytä ne myöhempiä tarvetta varten.

Διαβάστε αυτές τις οδηγίες προσεκτικά πριν χρησιμοποιήσετε το προϊόν για πρώτη φορά και φυλάξτε τις για μελλοντική αναφορά.

يرجى قراءة هذه التعليمات بدقة قبل البدء بالاستعمال والاحتفاظ بها كمرجع للمستقل

请在初次使用前仔细阅读这些指示，并保留它们以便未来参考。

初めてご使用になる前に、この説明書をよくお読みください。また、本書は将来いつでも参照できるように保管してください。

© 2015 Viacom Overseas Holdings C.V. All Rights Reserved. Teenage Mutant Ninja Turtles and all related titles, logos and characters are trademarks of Viacom Overseas Holdings C.V.

TMNT.MEGABLOKS.COM

U.S Patent N° D714,887

Design patents pending. En instance de brevets.



1

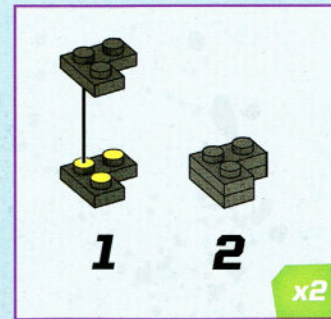
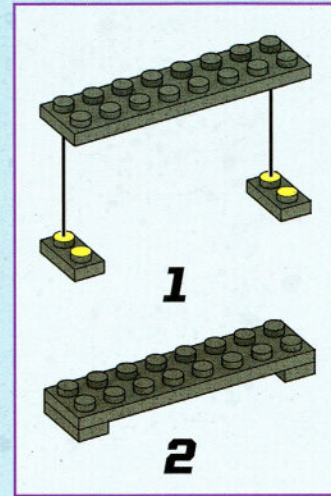
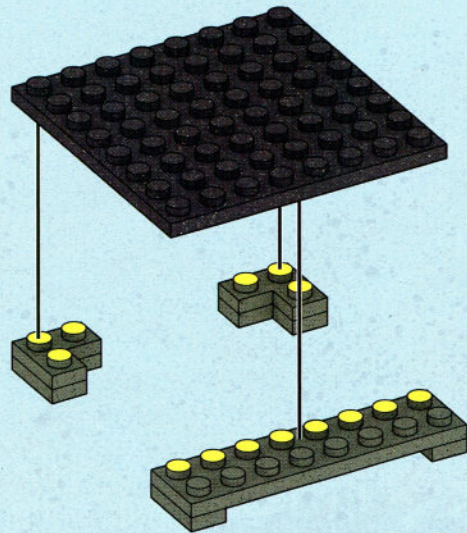
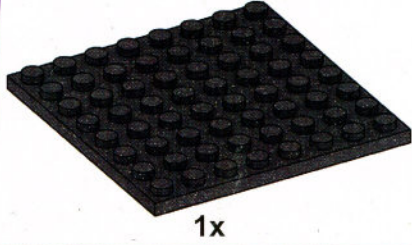
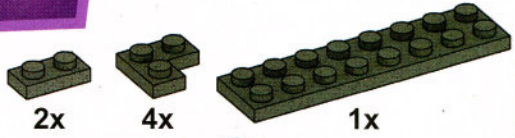

2



4x

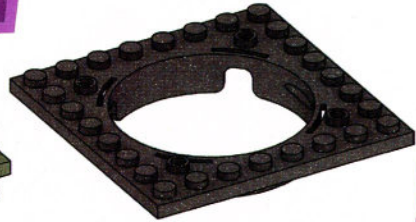

1x



1



2

x2

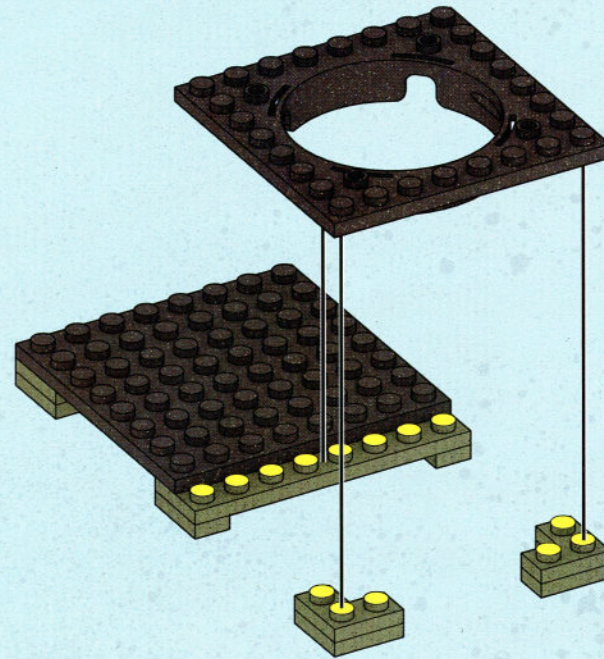

3



12x



12x

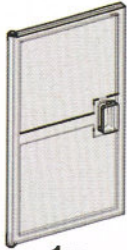

1x

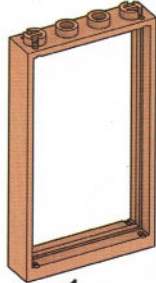

1x

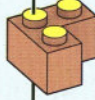
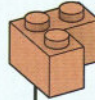
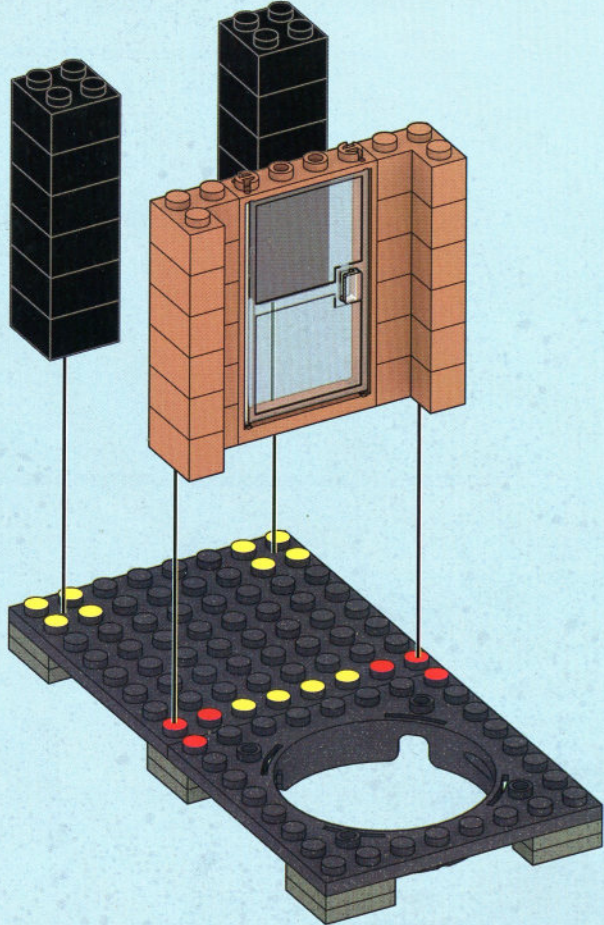

1



2

x2



1



2

x2

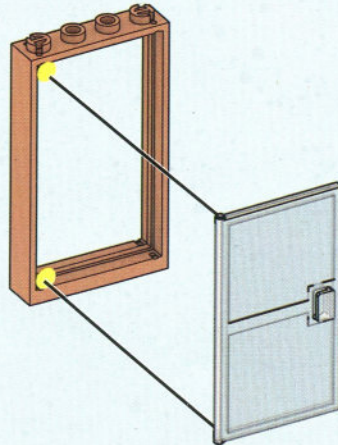

4

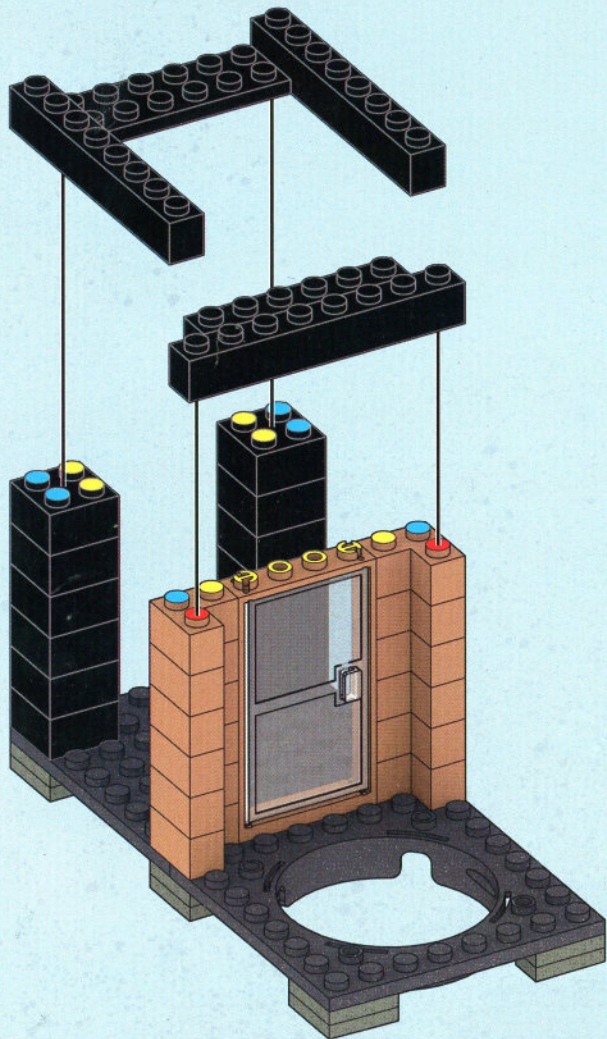
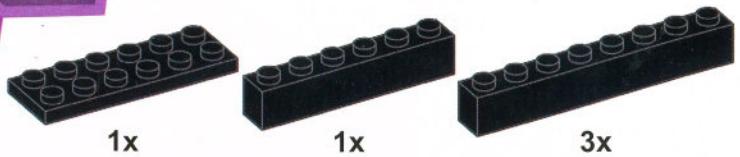

5

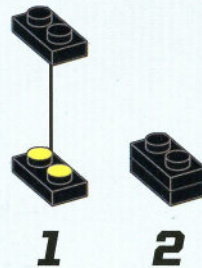
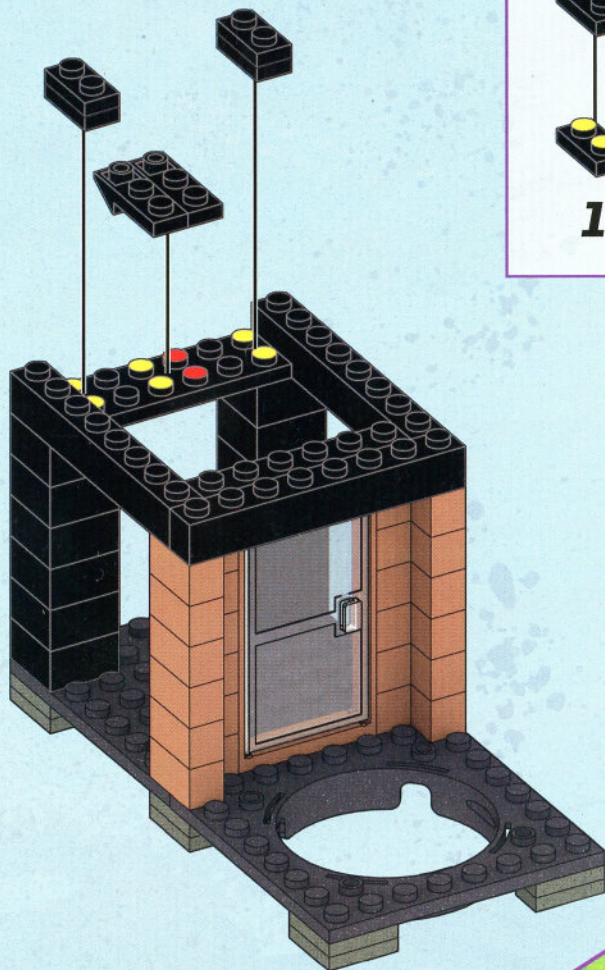
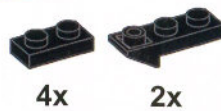

x2



6



1x

1x

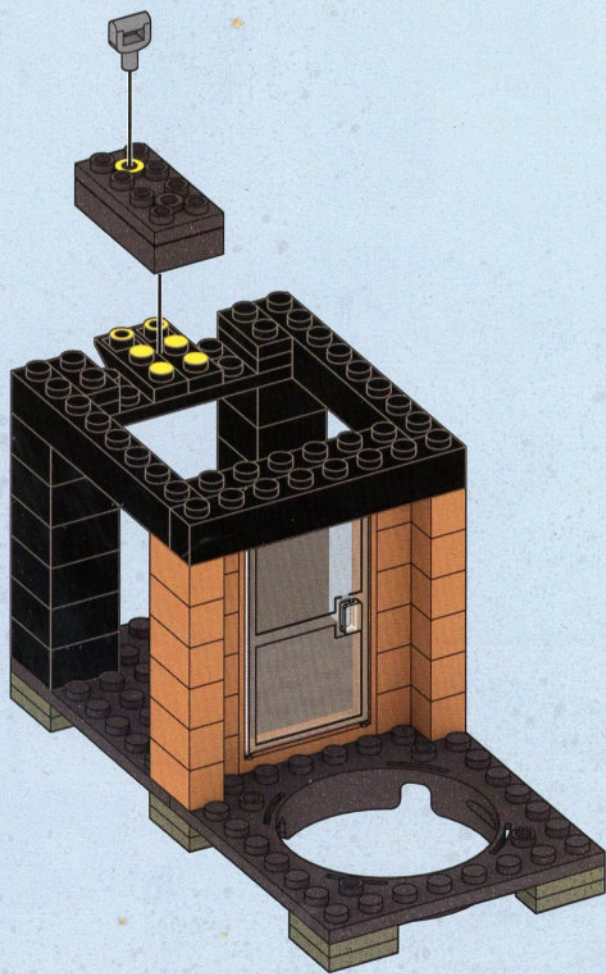

7

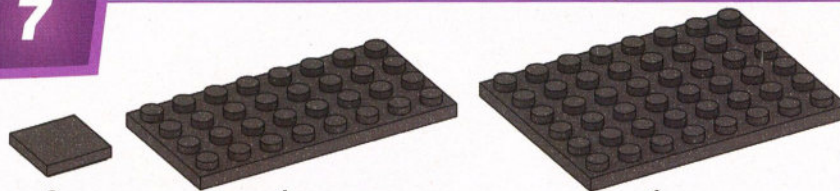

2x

1x

1x

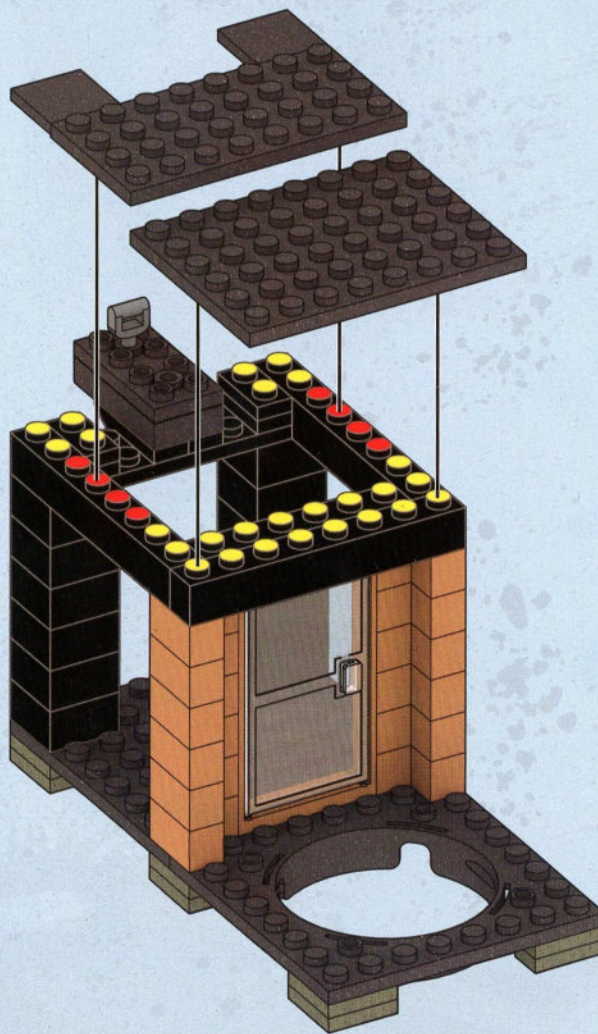

8

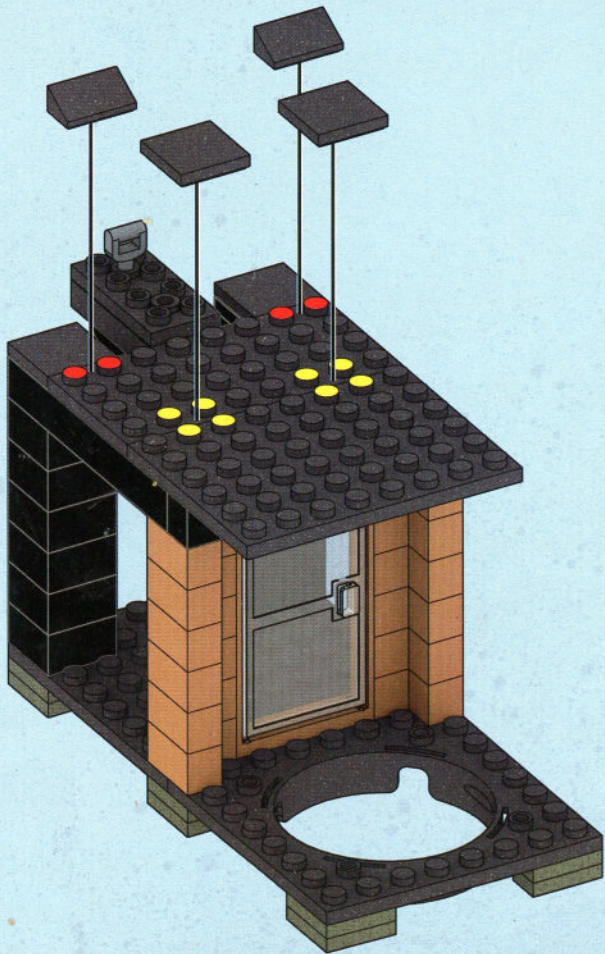

9

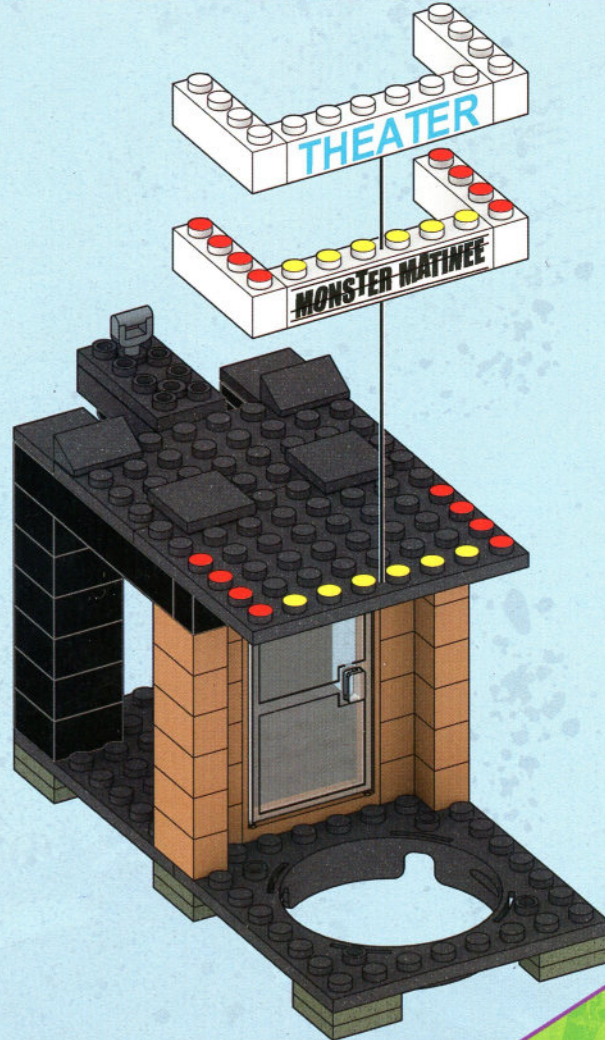
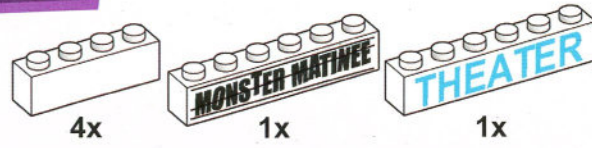

10



4x



2x



2x



2x

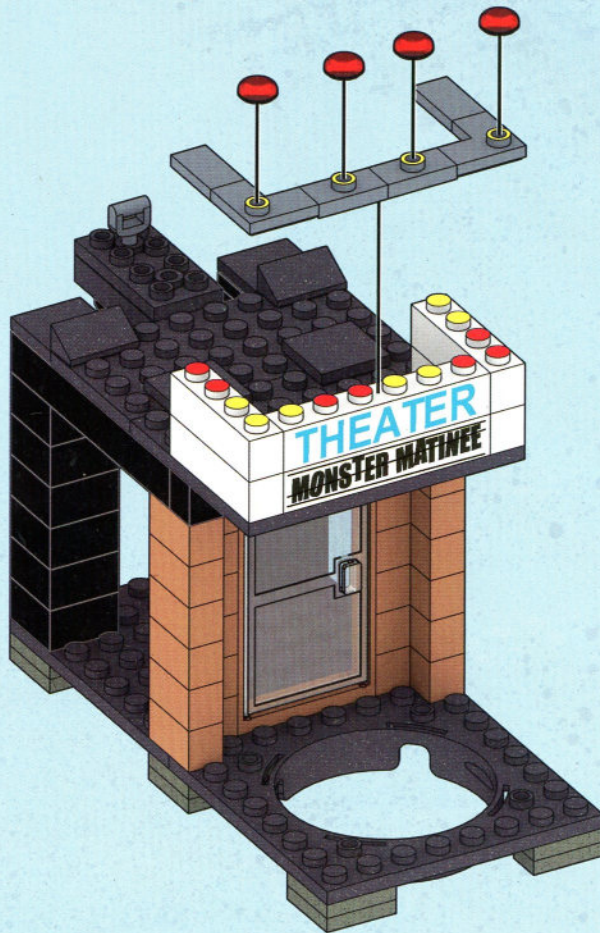

11

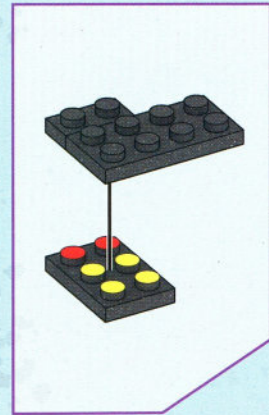
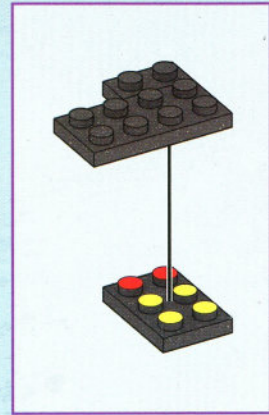
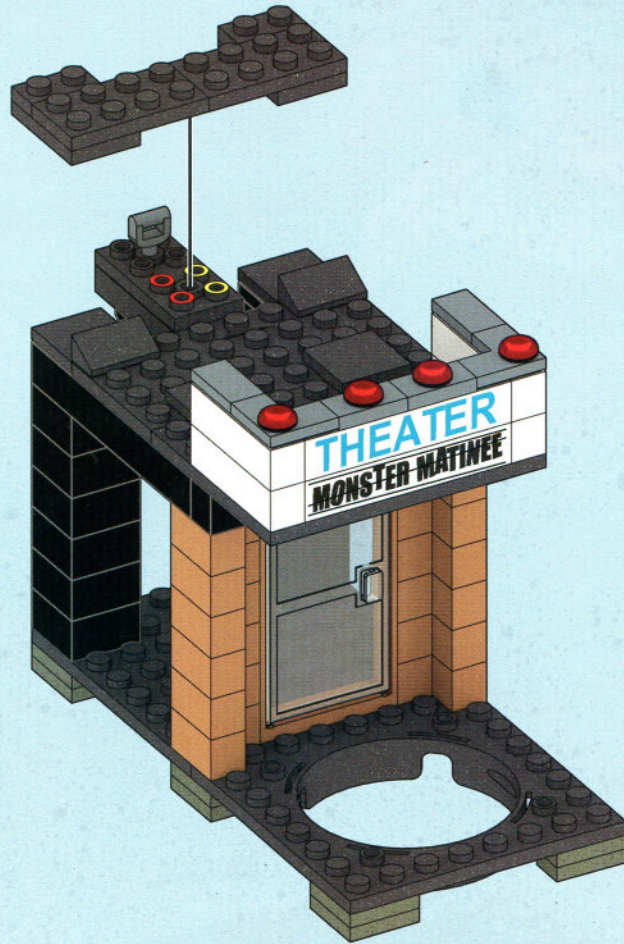
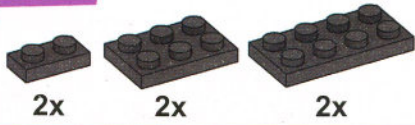

12

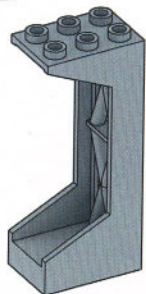

2x

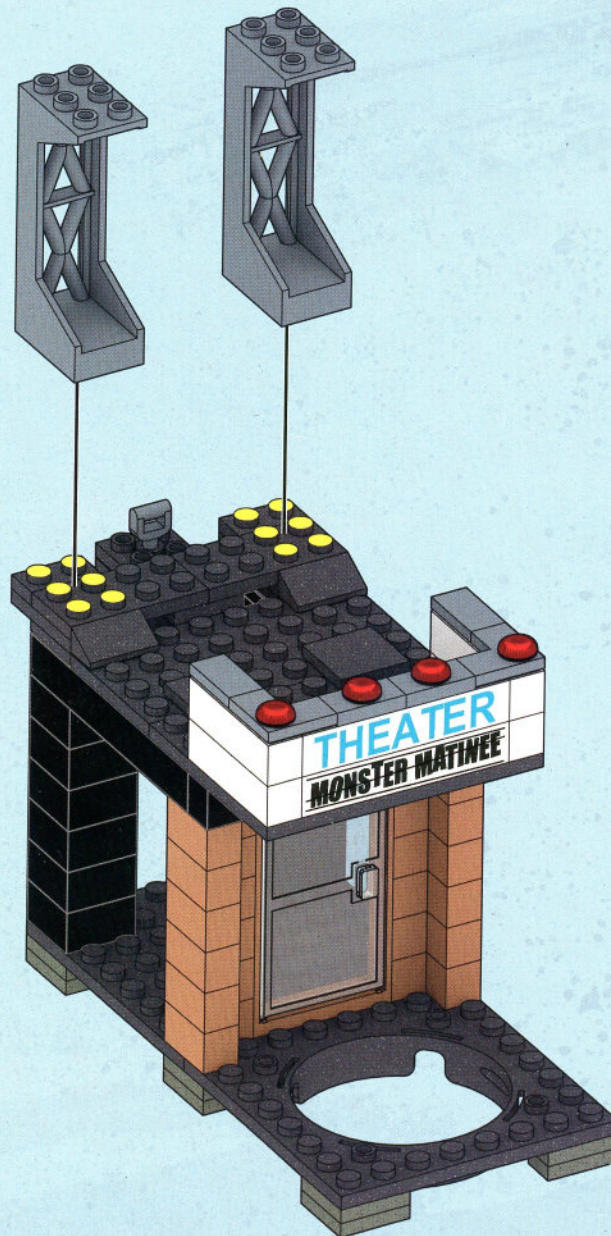

13



2x



2x



1x



1x

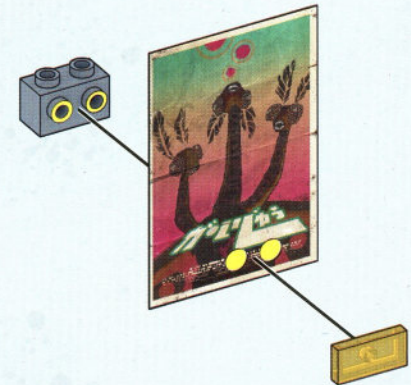
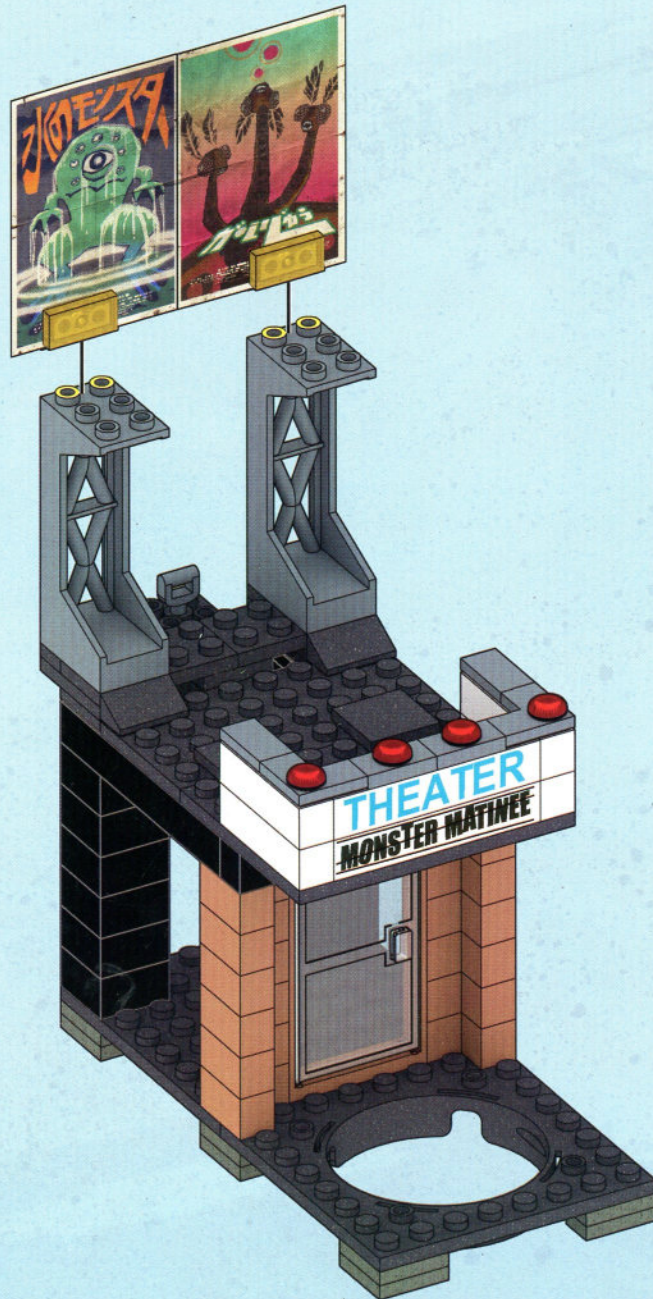

14



1x

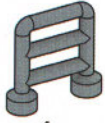

1x



1x



1x

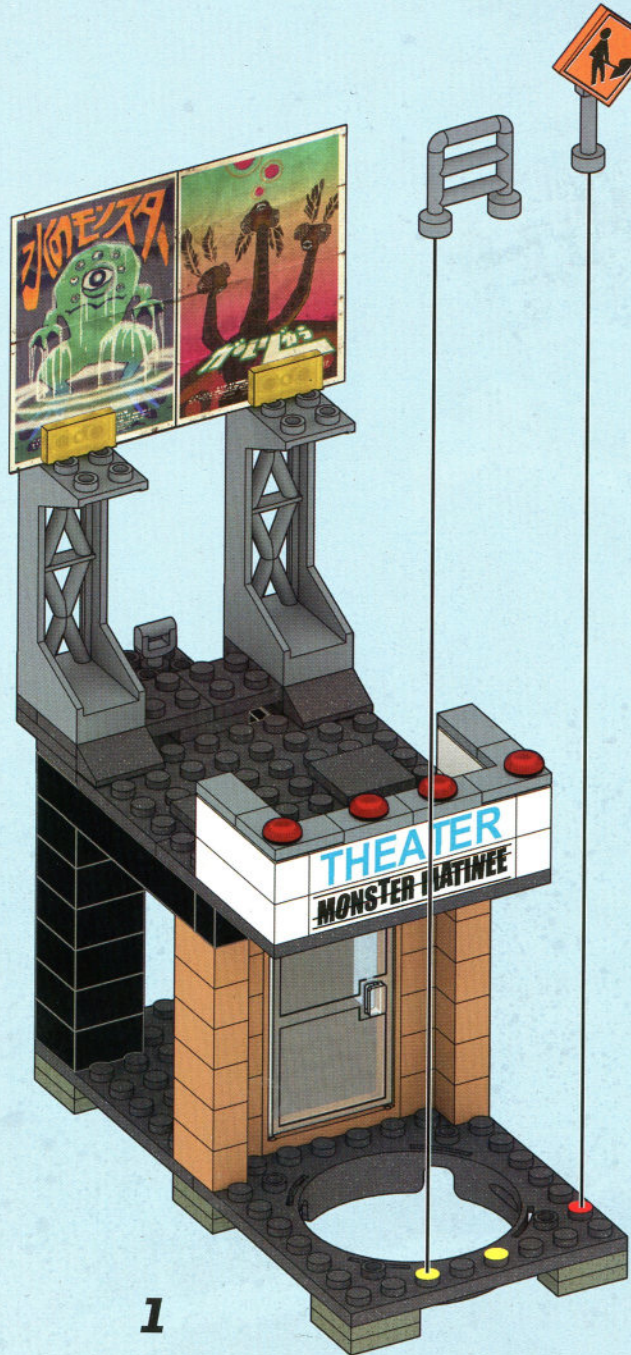
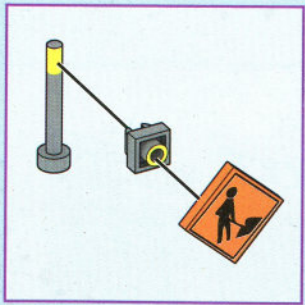

1

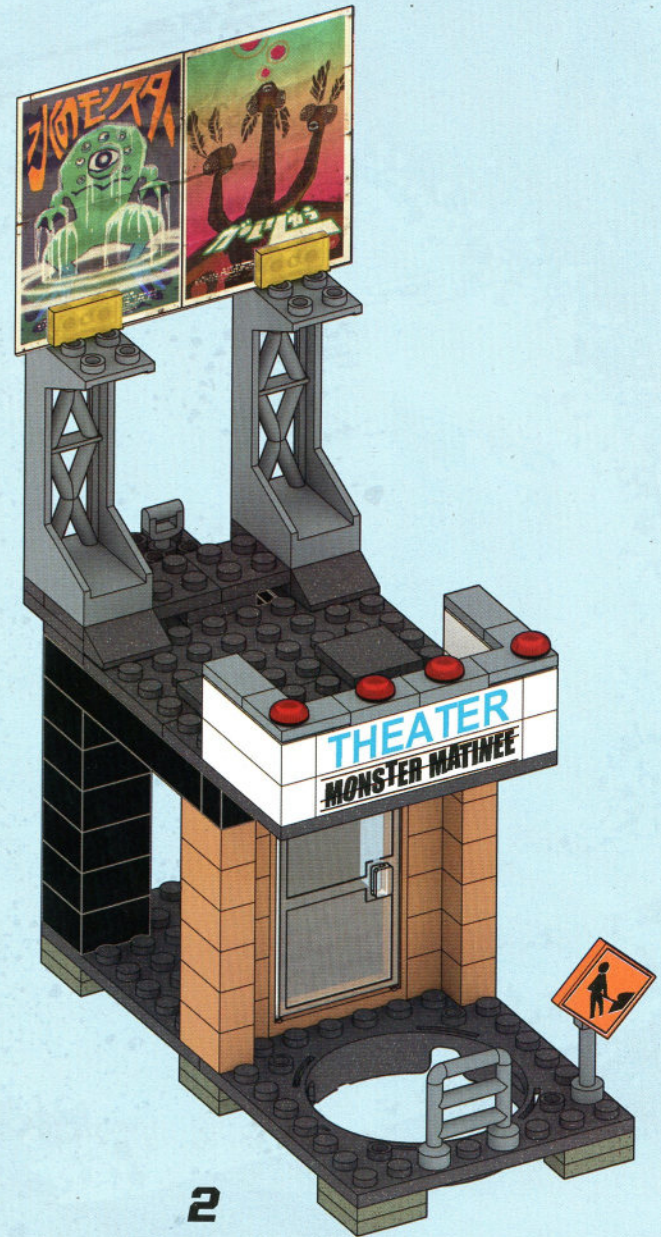

2

15



2x



1x



1x

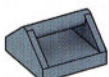

1x

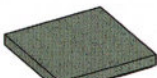

1x



1x



1x

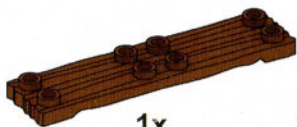

1x

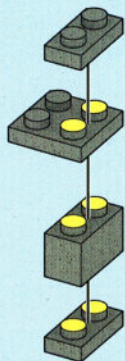

1

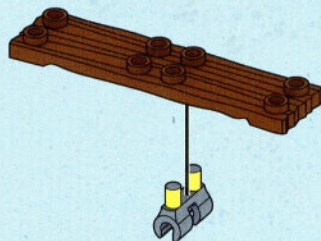

2

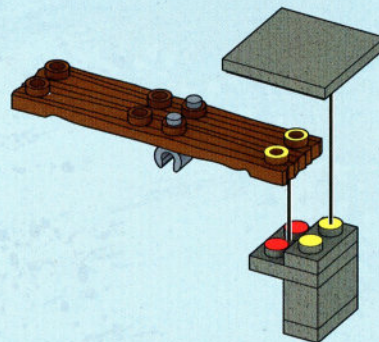

3

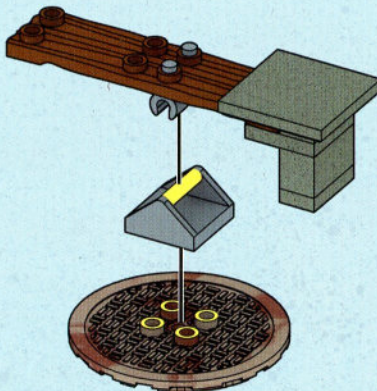

4

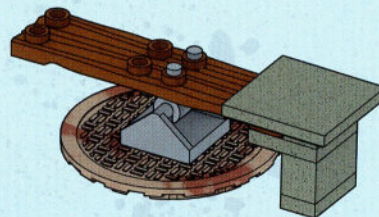

5



16



2x



1x



1



2

17



1x



1x



1



2

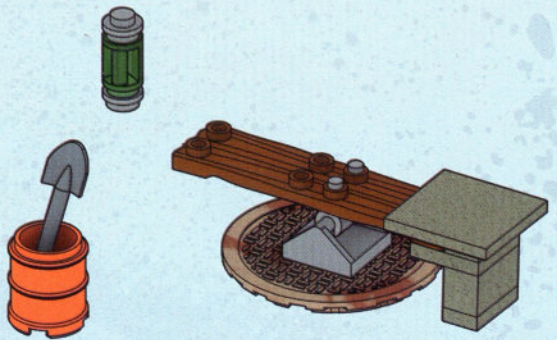
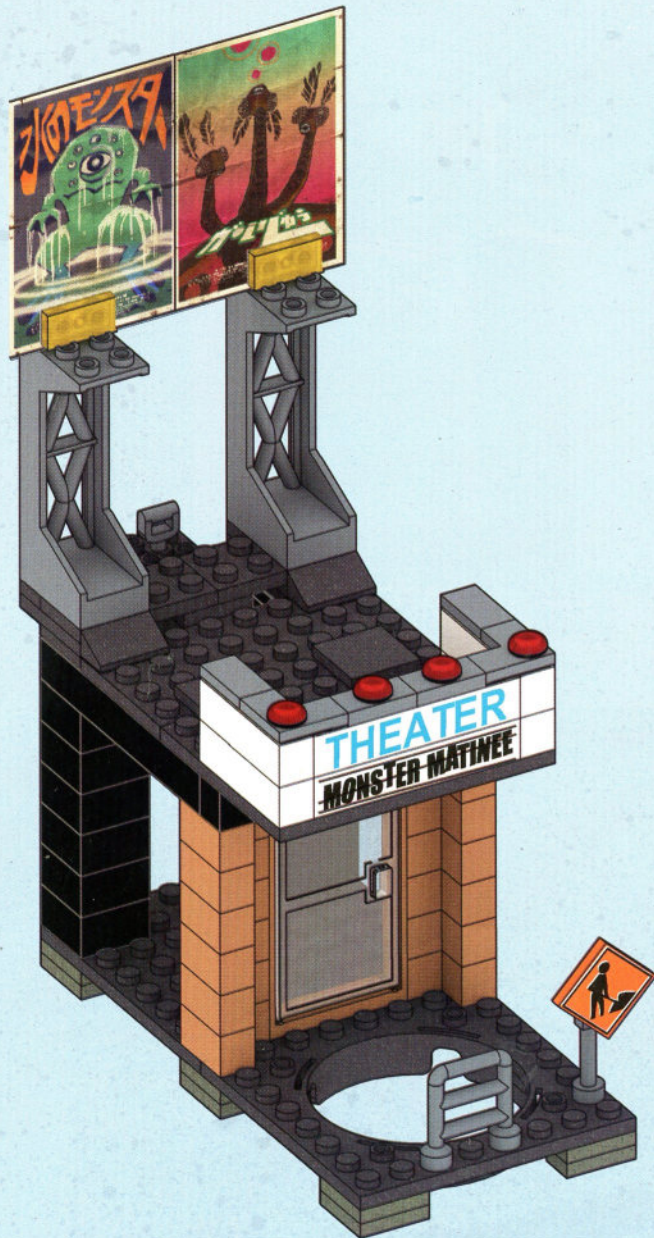



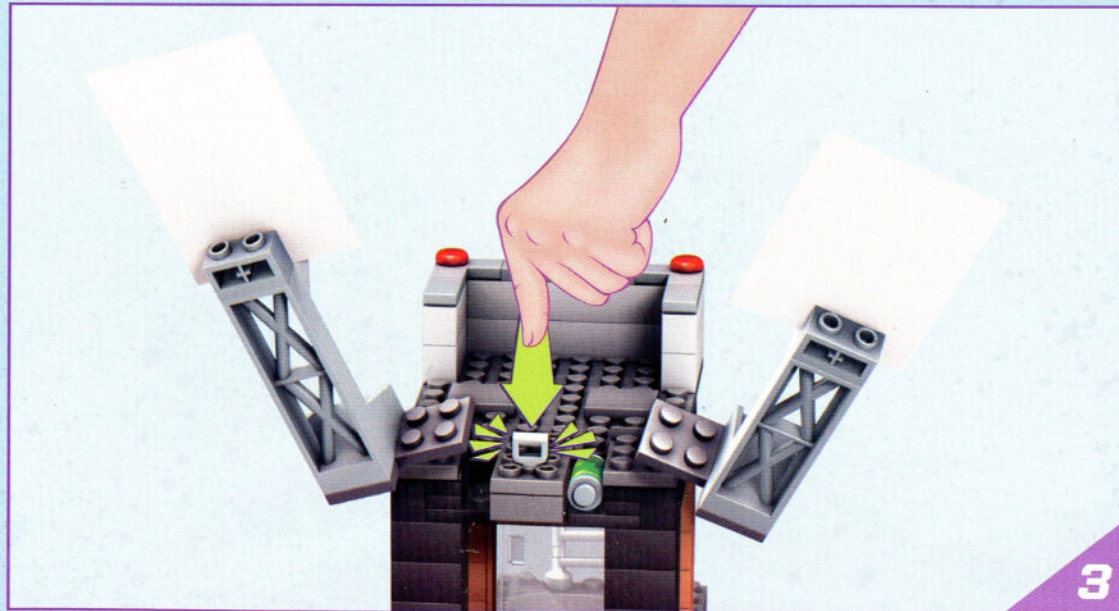
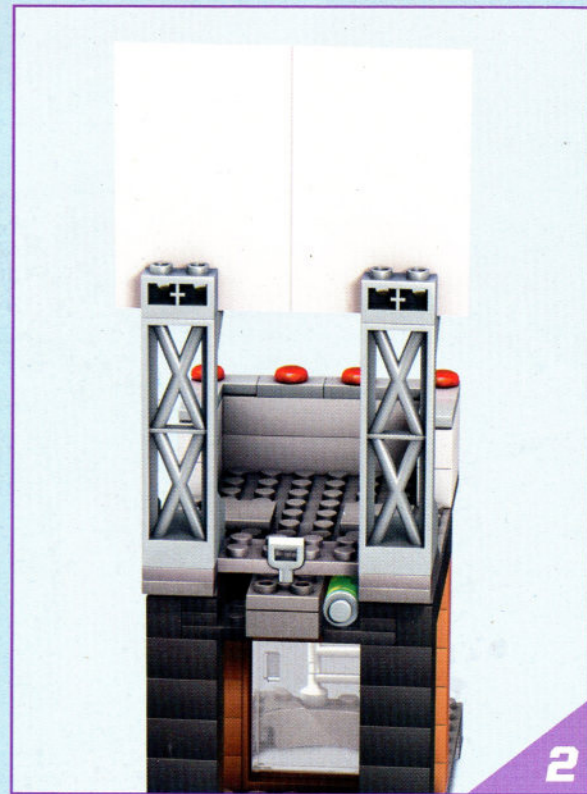
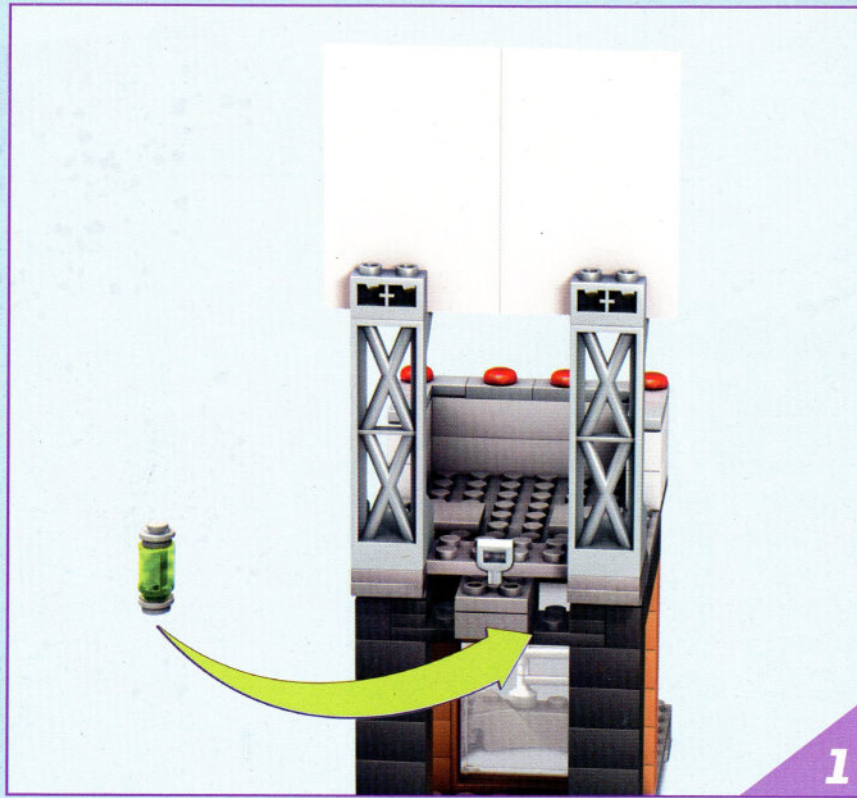



Each sold separately and subject to availability. / Tous vendus séparément. Certains produits peuvent ne pas être commercialisés. / Se venden por separado y están sujetos a disponibilidad. / Vendidos em separado e sujeitos à disponibilidade. / Ognuno in vendita separatamente secondo disponibilità. / Alle Artikel separat erhältlich. Einige Artikel werden nicht in allen Ländern vertrieben. / Sprzedawane oddzielnie w zależności od dostępności. / Per stuk verkrijgbaar en niet overal leverbaar. / Каждый продукт продается отдельно, в зависимости от наличия. / Sælges separat og så længe lager haves. / Alla delar säljs separat så långt lagret räcker. / Hver leke selges separat så langt lageret rekker. / Jokainen tuudään erikseen, saatavuus voi vaihdella. / Το καθένα πωλείται ξεχωριστά και ανάλογα με τη διαθεσιμότητα. / تباع كل منها على حدة وتخضع لتوفرها. 每件单独出售，并且视库存情况而定。 それぞれ在庫状況によって個別に販売されます。

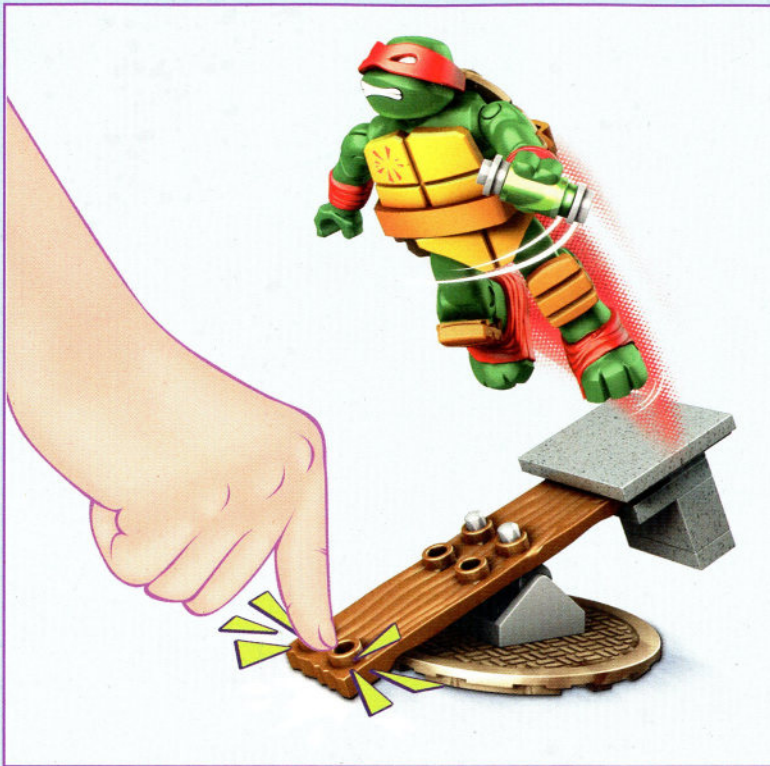

Warning: Do not aim at eyes or face. Only use projectiles supplied with this toy. Do not fire at point blank range.

Attention : Ne pas viser les yeux ou le visage. Ne pas utiliser d'autres projectiles que ceux fournis avec ce jouet. Ne pas tirer à bout portant.

Advertencia: No apuntar hacia los ojos o la cara. Utilizar exclusivamente los proyectiles suministrados con este juguete. No disparar a quemarropa.

Atenção! Não apontar para os olhos e para a face. Não utilizar projéteis diferentes dos providos. Não disparar excessivamente perto do alvo.

Attenzione: Non puntare agli occhi o al viso. Usa solo i proiettili forniti con il giocattolo. Non sparare a distanza ravvicinata.

Achtung: Nicht auf Augen oder Gesicht zielen. Nur die zu diesem Spielzeug gehörenden Projektilen verwenden. Nicht auf Menschen oder Tiere oder aus nächster Nähe zielen.

Ostrzeżenie: Nie celuj w oczy ani w twarz. Używaj wyłącznie rzutek BOOMco.™. Nie strzelaj z bliska.

Waarschuwing: niet op ogen of gezicht richten. Gebruik uitsluitend de bijgeleverde projectielen. Niet van te dichtbij afschieten.

Предупреждение: Не направляйте в глаза или лицо. Используйте только детали, входящие в комплект. Не стреляйте со слишком близкого расстояния.

Advarsel: Sigt ikke mod øjne eller ansigt. Brug kun de projektiler, som følger med legetøjet. Skyd ikke direkte på personer eller ting.

Varning! Sikta inte mot ögon eller ansikte. Använd endast projektiler som medföljer leksaken. Fyra inte av på mycket nära håll.

Advarsel: Du må ikke sikte mot øyne eller ansikt. Bruk bare prosjektilene som følger med leken. Ikke skyt på noe på kloss hold.

Varoitus: Älä tähtää silmiin eikä kasvoihin. Käytä ainoastaan tämän tuotteen mukana tulleita ammuksia. Älä ammu lähietäisyydeltä.

Προσοχή: Μη στοχεύετε στα μάτια ή στο πρόσωπο. Χρησιμοποιείτε μόνο τα βλήματα που περιλαμβάνονται. Μη στοχεύετε προς ανθρώπους ή ζώα.

تحذير: يجب عدم التصويب باتجاه العينين أو الوجه. يجب استخدام المقذوفات المزودة مع هذه اللعبة فقط. يجب عدم الإطلاق من مدى قريب.

警告: 请勿对着眼睛或脸部发射。仅使用本玩具自带的抛射物。请勿近距离射击。

警告: 目や顔を狙わないでください。このおもちゃに同梱されている発射物のみ使用するようになっています。到達可能な距離内で火を燃やさないでください。



**TURTLE POWER | PODER DE TORTUGA NINJA
 PODER DAS TARTARUGAS NINJA | МОЦ ŻÓЉWI
 ЧЕРЕПАШЬЯ СИЛА**



**SWIPING ACTION!
 ACTION LATÉRALE!
 ¡ACCIÓN DESLIZANTE! | GOLPE!
 ATTACCA LATERALMENTE!
 COOLE ANGRIFFSACTION!
 WYPROWADZA ATAK!
 AANVALLEN!
 КУЛАЧНЫЙ БОЙ!**



DMF64



**SLASHING ACTION! | ACTION
 DE FRAPPE! | ¡ACCIÓN DE ATAQUE!
 MOVIMENTOS DE BRAÇOS!
 AZIONE DEVASTANTE!
 SCHLAG-ACTION! | CIĘCIE! | WAT
 EEN ACTIE! | ФУНКЦИЯ УДАРОВ!**

DMX52

**ZIPLINE ACTION!
 ACTION SUR FILIN!
 ¡ACCIÓN DE CUERDA DE ESCAPE!
 ANDA DE SLIDE!
 AZIONE ECCLET!
 SEIL-AKTION! | TYROLKA!
 ZIPLIJNACTIE! | СКОРОСТНОЙ СПУСК!**



DMX51
 DMX55



**DOUBLE SLASHING ACTION!
 ACTION DOUBLE FRAPPE!
 ¡ACCIÓN DE DOBLE ATAQUE!
 DUPLO ATAQUE!
 DOPPIA AZIONE DEVASTANTE!
 DOPPELTE SCHLAG-ACTION!
 PODWÓJNE CIĘCIE!
 DUBBELE ACTIE!
 ДВОЙНЫЕ УДАРЫ!**



DMX54

YOU CAN COLLECT THEM ALL!
 À COLLECTIONNER! ¡COLECCIONALOS
 TODOS! | COLEZIONE TODOS!
 COLLEZIONALI TUTTI! | DU KANNST SIE
 ALLE SAMMELN! | MOŻESZ ZEBRAĆ JE
 WSZYSTKIE! | VERZAMEL ZE ALLEMAAL!
 ТЫ МОЖЕШЬ СОБРАТЬ ИХ ВСЕХ!



